

# MONITOR ARM COLLECTIONS

2024



**Fellowes**

A dark blue Fellowes monitor arm system is shown against a light grey background. The system consists of a vertical base, a horizontal arm, and a mounting plate. The mounting plate is grey and features a central circular cutout with a cross-shaped pattern. The arm is adjustable and has a locking mechanism. The base is a solid, dark blue rectangular block.

# INNOVATIONS THAT UNLEASH WORKLIFE POTENTIAL

Embrace the power of ergonomic design and customisable configurations that redefine worklife. Monitor arms are not just accessories; they are the cornerstone of a dynamic, efficient workspace. Enhance productivity, promote well being, and optimise office layouts with Fellowes Monitor Arms. Elevating office spaces has never been more accessible or rewarding, with a comprehensive collection of unique ranges.

For more than 100 years, Fellowes® has been helping people be the best they can be while at work. More productive. More efficient. Happier. Healthier. We are bonded by a century long commitment to creating workspace solutions that communicate care and respect, and we believe that with the right tools, everyone has the ability to fully harness their potential. Everything that carries the Fellowes name is a promise of quality, performance, innovation and outstanding customer service.

# MONITOR ARM COLLECTIONS



<b>Rising</b>	<b>4</b>
<b>Galaxy</b>	<b>8</b>
<b>Tallo</b>	<b>16</b>
<b>Chicago</b>	<b>21</b>
<b>Eppa</b>	<b>22</b>
<b>Smartview</b>	<b>23</b>
<b>Swing</b>	<b>24</b>
<b>Skylon</b>	<b>25</b>

# RISING™ MONITOR ARMS



Rising provides a design led solution with ease of reconfigurability and add-ons, providing even more function and flexibility to any workspace. With 12 total configurations to choose from, Rising facilitates maximum adjustability with one, two or three computer screens along with various ranges of height and length to fit unique needs. Rising stands out for its unique offering: a vibrant color palette comprising 9 different colors, including standard, premium, and in-trend finishes, that enhance workspaces wherever they may be, infusing them with a distinctive flair.

## SCREEN MOUNT OPTIONS



VESA



slider

## MOVEMENT LEVEL OPTIONS



static



gas spring

## DESK MOUNT OPTIONS



clamp



grommet



top mount

## ADJUSTABILITY OPTIONS



rotation



pan



tilt



rotation stop



red dot winner 2024



STEP 3



STEP 2



STEP 1



## SNAPKINET™

SnapKinect connection system allows the arm to be assembled and installed in 3 easy steps – so you can get to work faster than ever.



Standard

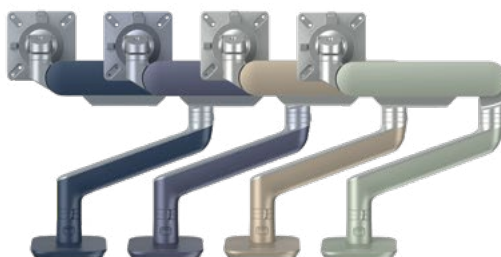

In-Trend



Premium

# RISING™ CONFIGURATIONS

## Rising™ Single Monitor Arm



Clamp/Grommet mount, VESA, max. 12.7 kg, gas spring.

Black	Silver	Platinum	Black/Bronze	Polished Aluminum	Azure	Slate	Sage	Stardust

100016610	100016611	100016612	100016613	100016614	100017194	100017196	100017195	100017197
-----------	-----------	-----------	-----------	-----------	-----------	-----------	-----------	-----------

## Rising™ Dual Monitor Arm



Clamp/Grommet mount, VESA Slider, max. 2 x 12.7 kg, gas spring.

Black	Silver	Platinum	Black/Bronze	Polished Aluminum	Azure	Slate	Sage	Stardust

100016615	100016616	100016617	100016618	100016619	100017198	100017200	100017199	100017202
-----------	-----------	-----------	-----------	-----------	-----------	-----------	-----------	-----------

## RisingEX™ 1F Monitor Arm



Clamp/Grommet mount, VESA, max. 12.7 kg, static.

Black	Silver	Platinum	Black/Bronze	Polished Aluminum	Azure	Slate	Sage	Stardust

100040055	100040056	100040057	100040058	100040059	100036383	100038340	100038338	100038339
-----------	-----------	-----------	-----------	-----------	-----------	-----------	-----------	-----------

## RisingEX™ 1FF Monitor Arm



Clamp/Grommet mount, VESA, max. 12.7 kg, static, extra reach.

Black	Silver	Platinum	Black/Bronze	Polished Aluminum	Azure	Slate	Sage	Stardust

100040062	100040066	100040067	100040076	100040077	100036384	100038343	100038341	100038342
-----------	-----------	-----------	-----------	-----------	-----------	-----------	-----------	-----------

## RisingEX™ 1M Monitor Arm



Clamp/Grommet mount, VESA, max. 12.7 kg, gas spring.

Black	Silver	Platinum	Black/Bronze	Polished Aluminum	Azure	Slate	Sage	Stardust

100040078	100040079	100040080	100040081	100040082	100036386	100038349	100038347	100038348
-----------	-----------	-----------	-----------	-----------	-----------	-----------	-----------	-----------

# RISING™ CONFIGURATIONS

## RisingEX™ 1FM Monitor Arm



Clamp/Grommet mount, VESA, max. 12.7 kg, gas spring, extra reach.



Black



Silver



Platinum



Black/Bronze



Polished Aluminum



Azure



Slate



Sage



Stardust

100040083

100040084

100040085

100040086

100040087

100036385

100038346

100038344

100038345

## RisingEX™ 2FS Monitor Arm



Clamp/Grommet mount, VESA, slider, max. 2 x 12.7 kg, static.



Black



Silver



Platinum



Black/Bronze



Polished Aluminum



Azure



Slate



Sage



Stardust

100043326

100043327

100043331

100043332

100043333

100036387











100038328











100038326











100038327























# RISING™ CONFIGURATIONS

RisingEX™ 2FFS Monitor Arm										
	Clamp/Grommet mount, VESA slider, max. 2 x 12.7 kg, static, extra reach.									
										
	Black	Silver	Platinum	Black/Bronze	Polished Aluminum	Azure	Slate	Sage	Stardust	
	100043334	100043335	100043336	100043337	100043401	100038336	100039314	100039313	100039315	

RisingEX™ 2MS Monitor Arm										
	Clamp/Grommet mount, VESA slider, max. 2 x 12.7 kg, gas spring.									
										
	Black	Silver	Platinum	Black/Bronze	Polished Aluminum	Azure	Slate	Sage	Stardust	
	100043444	100043445	100043446	100043447	100043448	100036389	100038335	100038333	100038334	

RisingEX™ 2FMS Monitor Arm										
	Clamp/Grommet mount, VESA Slider, max. 2 x 12.7 kg, gas spring, extra reach.									
										
	Black	Silver	Platinum	Black/Bronze	Polished Aluminum	Azure	Slate	Sage	Stardust	
	100043820	100043821	100043823	100043824	100043825	100036388	100038332	100038330	100038331	

RisingEX™ 3FFS Monitor Arm										
	Clamp/Grommet mount, VESA Slider, max. 3 x 12.7 kg, static.									
										
	Black	Silver	Platinum	Black/Bronze	Polished Aluminum	Azure	Slate	Sage	Stardust	
	100043831	100043832	100043833	100043834	100043835	100038337	100039318	100039316	100039317	

RisingEX™ 3FMS Monitor Arm										
	Clamp/Grommet mount, VESA Slider, max. 3 x 12.7 kg, gas spring.									
										
	Black	Silver	Platinum	Black/Bronze	Polished Aluminum	Azure	Slate	Sage	Stardust	
	100016620	100016621	100016622	100016623	100016624	100017203	100017205	100017204	100017206	

# GALAXY

## MONITOR ARMS | STANDARD CONFIGURATIONS

Fully modular system for workspaces that use up to 10 monitors.

Galaxy is perfect for specialized setups, building limitless custom configurations. The Galaxy range is available in a selection of standard configurations, as well as bespoke kits to meet specific project requirements.



### SCREEN MOUNT OPTIONS



VESA

### MOVEMENT LEVEL OPTIONS



static



gas spring

### DESK MOUNT OPTIONS



clamp

### ADJUSTABILITY OPTIONS



rotation



pan



tilt



rotation stop



Black











White







Silver





# GALAXY STANDARD CONFIGURATIONS





Galaxy 1 Single Short Monitor Arm			
	45 cm pole height, VESA directly mounted to the pole, max. 20 kg.		
			
	Black	White	Silver
	100091377	100091558	100091339

Galaxy 1FF Monitor Arm			
	45 cm pole height, 2x fixed arm components for extra reach, max. 20 kg.		
			
	Black	White	Silver
	100091344	100091453	100091620

Galaxy 1FM Monitor Arm			
	22 cm pole height, 1x fixed arm component 1x motion arm for dynamic movement, max. 12 kg.		
			
	Black	White	Silver
	100091343	100091381	100091510



Galaxy 2FM Dual Monitor Arm			
	22 cm pole height, 1x fixed arm component 1x motion arm for dynamic movement, each max. 12 kg.		
			
	Black	White	Silver
	100091465	100091609	100091464

Galaxy 2FF Dual Monitor Arm			
	45 cm pole height, 2x fixed arm components for extra reach, each max. 20kg.		
			
	Black	White	Silver
	100091385	100091597	100091628

# BUILD YOUR OWN GALAXY MONITOR ARMS | MODULAR COMPONENTS

Discover a universe of possibilities with the Galaxy range. Tailor the setup by selecting the ideal clamp, height, screen accommodation, movement level, reach, monitor mounting option, and accessories from our selection of components. Rely on the expertise of Fellowes professionals, equipped with comprehensive ergonomic knowledge, to craft a tailored proposal. Benefit from solutions that strike the perfect balance between essentials and ergonomic excellence, enhancing both productivity and wellbeing.

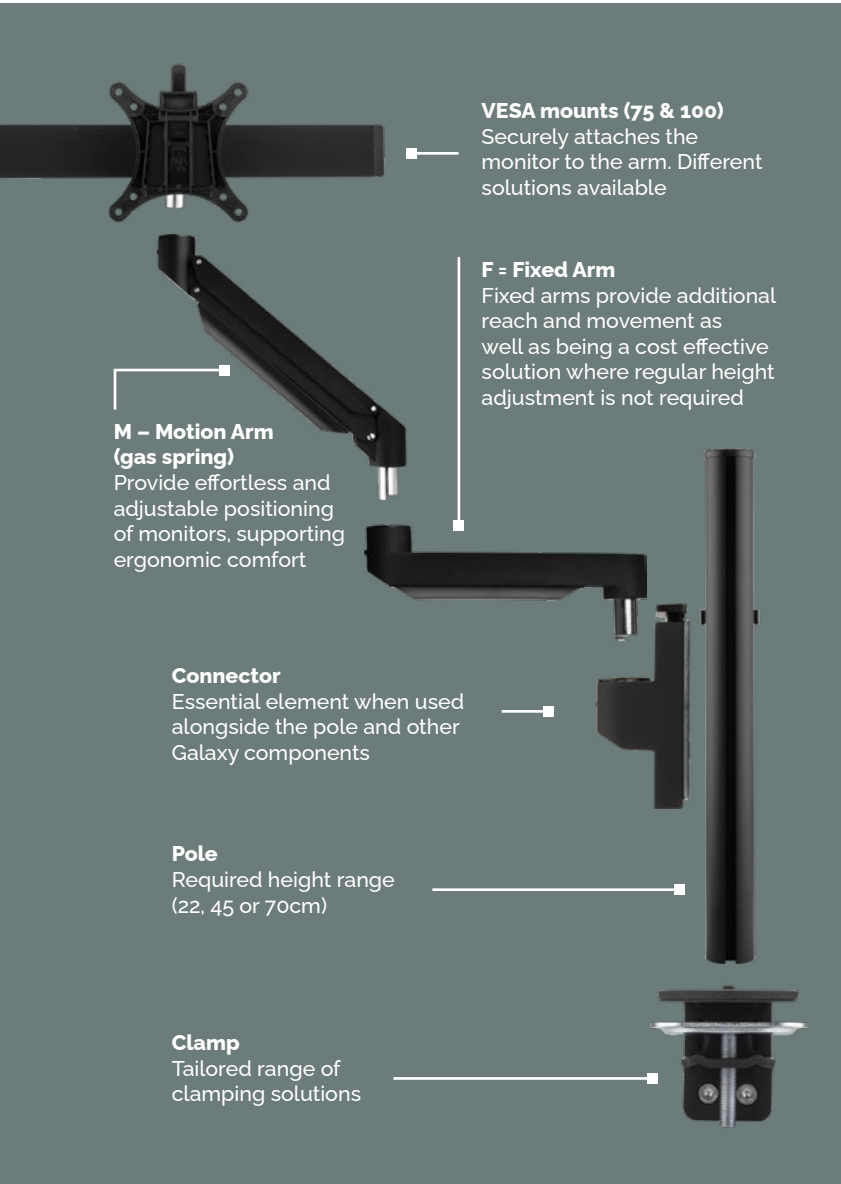

## SCREEN MOUNT OPTIONS

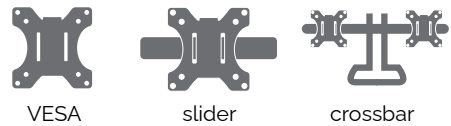

## MOVEMENT LEVEL OPTIONS

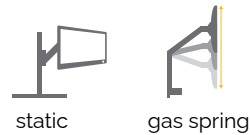

## DESK MOUNT OPTIONS

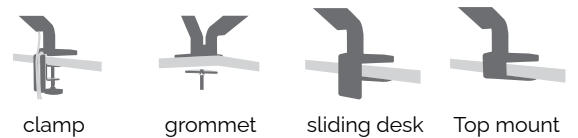



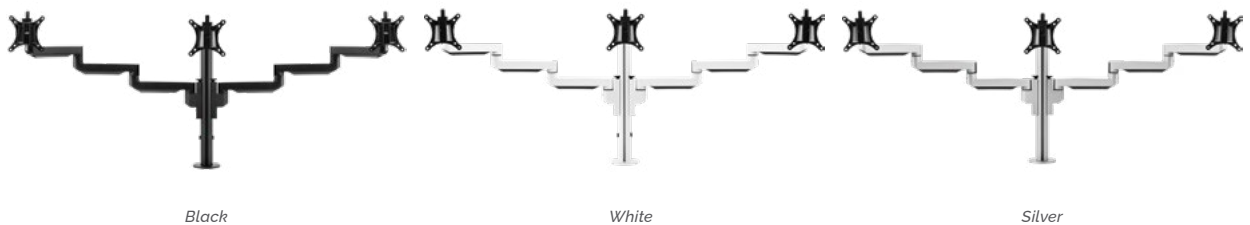

## ADJUSTABILITY OPTIONS











# GALAXY MODULAR COMPONENTS

## CLAMPS

The style and configuration of the desktop will determine the most suitable clamp/ clamp required. Choose from a wide range of clamp options.

Galaxy Desk Clamp			
	Regular clamp, desktop range 0 - 80 mm.		
			
	Black	White	Silver
	100091373	100091350	100091493

Galaxy Desk Clamp/Grommet			
	non-pole mounted clamp, desktop range 0 - 96 mm.		
			
	Black	White	Silver
	100091424	100091364	100091655

Galaxy Grommet			
	Grommet mount, desktop range 10 - 60 mm.		
			
	Black	White	Silver
	100091543	100091439	100091672

Galaxy Sliding Desk Clamp			
	Special design for sliding desks, desktop range 8 - 28 mm.		
			
	Black	White	Silver
	100091506	100091547	100091334



Galaxy Top Mount Clamp			
	Top mount, 0 - 45 mm, combine with the pole or with the Adapter to create a single configuration without pole.		
			
	Black	White	Silver
	100091671	100091502	100091430

Galaxy Adapter			
	Combine with Galaxy top mount clamp.		
			
	Black	White	Silver
	100091592	100091429	100091394

## UNIVERSAL TOOLBAR / WALL MOUNT

Use in combination with the toolbar.

Transform to universal wall mount by unscrewing from the metal box and directly screw to any wall.

Galaxy Universal Toolbar / Wall Mount			
	Use in combination with toolbar or to mount to wall.		
			
	Black	White	Silver
	100091420	100091603	100091654











# GALAXY MODULAR COMPONENTS

## POLES

Available in three distinct heights & interconnectable for height alterations.

Interconnect posts (M8 screw) for quick alterations in height.

The post has 4 identical sides that can hold the connector, desk up & CPU holder.

Galaxy Poles										
	Three height options are available, essential for any Galaxy monitor arm setup. Pair with any of the four clamp designs: Desk Clamp, Grommet, Sliding Desk Clamp, and Top Mount Clamp.									
										
	Black	White	Silver	Black	White	Silver	Black	White	Silver	
	22 cm			45 cm			70 cm			
	<b>100091480</b>	<b>100091615</b>	<b>100091534</b>	<b>100091646</b>	<b>100091466</b>	<b>100091634</b>	<b>100091443</b>	<b>100091599</b>	<b>100091433</b>	

## CONNECTORS



This is a crucial component in constructing any monitor arm configuration. To install, simply press the top button to slide it into the pole, and once in place, it can be easily repositioned by pressing and sliding it up or down as needed. Integrate any monitor arm component into the connector to initiate the expansion of reach and dynamic adjustability. Alternatively, directly attach one of the VESA options to the connector when additional reach is unnecessary or when supporting a heavy-duty, curved screen or two screens on a crossbar.

Galaxy Connector			
	Necessary accessory for all arm solutions in combination with the pole.		
			
	Black	White	Silver
	<b>100091481</b>	<b>100091660</b>	<b>100091356</b>

# GALAXY MODULAR COMPONENTS





## ARMS

Select from various options such as gas spring arm, horizontal static arm, and slanted arm, to tailor any monitor arm configuration to suit specific needs. Gas spring arms are ideal for scenarios requiring dynamic height adjustability, with heavy-duty options available to accommodate heavier monitors such as curved screens. To extend the reach of the monitor arm, the straight arm component can be employed, allowing for the attachment of up to four straight arm components for a single monitor setup. Alternatively, the slanted arm component offers static height and reach capabilities when necessary.

Galaxy Gas Spring Arm Component			
	28 cm of height freedom max. weight limit 2- 12 kg per gas spring arm		
			
	Black*	White	Silver
	100091427	100091414	100091348

\*heavy duty gas spring monitor arm available in black & white - on request 10 - 20kg

Galaxy Straight Arm Component			
	24 cm reach, max 20kg		
			
	Black	White	Silver
	100091379	100091525	100091434





Galaxy Slanted Arm Component			
	25 cm reach, max 20kg		
			
	Black	White	Silver
	100091367	100091575	100091392

# GALAXY MODULAR COMPONENTS

## VESA

Our VESA heads are designed to accommodate monitors with VESA 75 x 75 and 100 x 100 standards. Various VESA options are available, each influencing the range of movement: pan, tilt, and rotate features provide flexibility, while sliders (the precision aligners) facilitate horizontal monitor adjustments. Additionally, static options are available for compatibility with crossbars or heavy-duty monitor arms.

Galaxy VESA Head			
	VESA mount that can pan, tilt & rotate.		
			
	Black	White	Silver
100091361	100091338	100091354	



Galaxy Vesa Head For Crossbar			
	Mount directly to the connector or arm components and mount the crossbar or the VESA Slider to this VESA head.		
			
	Black	White	Silver
100091432	100091449	100091507	



Galaxy VESA Slider - Black	
	Compatible with all VESA plates (75 & 100). Adds a depth of 100mm. Width range of 310mm.
	Note: When combined with the VESA head for the crossbar, it provides combined depth of 184 mm.
	
	Black
	100091389



Galaxy Direct-Connect VESA Slider	
	The direct connect slider seamlessly integrates with all connectors and arm components, offering a depth of 97 mm and a width range of 310 mm (center of the VESA plate).
	
	Black
	100111770



## CROSSBAR

A crossbar is utilized in conjunction with two or three monitors to provide for a space saving solution and perfect alignment of the two monitors.

Galaxy Crossbar	
	With VESA connection, fits to any VESA 75 or 100. VESA plates on either side rotate, pan & tilt
	
	Black
	100091482

Galaxy Direct-Connect Crossbar   2x27" Monitors	
	Connects directly into monitor arm component or connector. VESA plates on either side rotate, pan & tilt.
	
	Black
	100091569







Galaxy Direct-Connect Crossbar   2x34"	
	Heavy duty crossbar suitable for screens up to 34", including 2 joints
	
	Black
	100115565

Galaxy Direct-Connect Crossbar   3x27" Monitors	
	Crossbar that holds 3 monitors up to 27", including 2 joints
	
	Black
	100115572

# GALAXY MODULAR COMPONENTS

## TOOLBAR

Combine with two poles, each 45 or 70 cm and built a workspace that's suited for up to 10 monitors.

Galaxy Toolbar						
	Mount between 2 x 45 or 70 cm poles. Create workspaces for up to 10 monitors.*					
						
	Black	White	Silver	Black	White	Silver
	120 cm			150 cm		
	<b>100091541</b>	<b>100091475</b>	<b>100091390</b>	<b>100091584</b>	<b>100091532</b>	<b>100091554</b>

\* Image is showing the toolbar alongside 2x poles. Please note that the product includes only the toolbar and does not include the poles, arms & mounts. These are all separate components.







## ACCESSORIES

Finish the monitor arm set up with a choice of accessories to meet user requirements.

Galaxy Power			
	Accessory to mount Desk Up 1.0 to the pole.		
			
	Black	White	Silver
	<b>100091651</b>	<b>100091328</b>	<b>100091376</b>

Galaxy Laptop Accessory	
	Universal use, suited for laptops up to 17", compatible with all VESA 75 & 100.
	
	Black
	<b>100091594</b>

Galaxy CPU Holder			
	Compatible with the Galaxy pole. Slide in, lock tight and place the CPU.		
			
	Black	White	Silver
	<b>100091336</b>	<b>100091498</b>	<b>100091637</b>

Sit-Stand Platform		
	Easily integrate this keyboard platform into the Galaxy configuration for optimal versatility, when combined with a 70cm pole, connector & static arm to create a standing workspace.	
		
	Black	White
	<b>100091641</b>	<b>100091511</b>

# TALLO™ MONITOR ARMS



Tallo™ not only reimagines how a monitor arm can facilitate productive work, but enriches it through human-centered design. Modern in appearance, robust in performance, Tallo™ makes any desk a productive space for comfortable, meaningful work.



reddot winner 2022



GERMAN  
DESIGN  
AWARD  
WINNER  
2024

## SCREEN MOUNT OPTIONS



VESA



slider

## MOVEMENT LEVEL OPTIONS



gas spring

## DESK MOUNT OPTIONS



clamp



grommet



top mount

## ADJUSTABILITY OPTIONS



rotation



pan



tilt



rotation stop



Black





White



Silver

# TALLO™ CONFIGURATIONS





## Tallo™ Single Monitor Arm

	Clamp/Grommet mount, VESA, max. 9 kg, max. 40", gas spring.		
			
	Black	White	Silver
	<b>8614301</b>	<b>8614601</b>	<b>8613001</b>



## Tallo™ Single Monitor Arm - top mount

	Clamp/Grommet mount, VESA, max. 9 kg, max. 40" gas spring.	
		
	Black	White
	<b>8703301</b>	<b>8703201</b>

## Tallo™ Dual Monitor Arm

	Clamp/Grommet mount, VESA Slider, max. 2 x 9kg, max. 40", gas spring, extra reach.		
			
	Black	White	Silver
	<b>8614401</b>	<b>8614701</b>	<b>8613101</b>

## Tallo™ Dual Monitor Arm - Top Mount



	Clamp/Grommet mount, VESA Slider, max. 2 x 9kg, max. 40", gas spring, extra reach.	
		
	Black	White
	<b>100016227</b>	<b>100016226</b>



## Tallo™ Dual Compact Monitor Arm

	Clamp/Grommet mount, VESA Slider, max. 2 x 9kg, max. 40", gas spring.		
			
	Black	White	Silver
	<b>8614501</b>	<b>8614801</b>	<b>8613201</b>

## Tallo™ Dual Compact Monitor Arm - Top Mount

	Clamp/Grommet mount, VESA Slider, max. 2 x 9kg, max. 40", gas spring.	
		
	Black	White
	<b>8703501</b>	<b>8703401</b>

# TALLO MODULAR™ MONITOR ARMS



Unleash the versatility of Tallo Modular – meticulously designed to elevate any workspace. Experience extended reach and 50cm height adjustability in monitor arms, accommodating up to four screens for enhanced productivity. Choose from three sophisticated colours to seamlessly integrate style and functionality. Elevate workspaces with Tallo Modular – where form meets function in perfect harmony.

**S = Slider**  
Sliders increase the size of screens an arm can hold whilst enabling you to place screens seamlessly side by side. This helps to save valuable desk space and maintain an ergonomic working position.

**M – Motion Arm (gas spring)**  
Motion arms deliver effortless gas spring height adjustment, great for hot desking and collaborative working.

**F = Fixed Arm**  
Fixed arms provide additional reach and movement as well as being a cost effective solution where regular height adjustment is not required.

red dot winner 2022



## SCREEN MOUNT OPTIONS

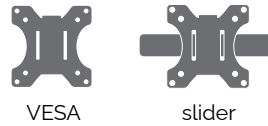

## MOVEMENT LEVEL OPTIONS

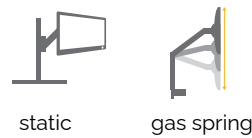

## DESK MOUNT OPTIONS

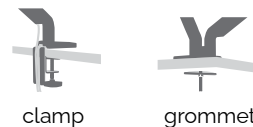

## ADJUSTABILITY OPTIONS



Black







White







Silver

# TALLO MODULAR™ CONFIGURATIONS





Tallos Modular™ 1F Monitor Arm			
	Clamp/Grommet mount, VESA, max. 1 x 9kg, max. 40", static.		
			
	Black	White	Silver
	<b>8614901</b>	<b>8615901</b>	<b>8613301</b>

Tallos Modular™ 1FF Monitor Arm			
	Clamp/Grommet mount, VESA, max. 1 x 9kg, max. 40", static, extra reach.		
			
	Black	White	Silver
	<b>8615001</b>	<b>8616001</b>	<b>8613401</b>

Tallos Modular™ 1M Monitor Arm			
	Clamp/Grommet mount, VESA, max. 9 kg, max. 40", gas spring.		
			
	Black	White	Silver
	<b>8615201</b>	<b>8616201</b>	<b>8613601</b>

Tallos Modular™ 1FM Monitor Arm			
	Clamp/Grommet mount, VESA, max. 9 kg, max. 40", gas spring, extra reach.		
			
	Black	White	Silver
	<b>8615101</b>	<b>8616101</b>	<b>8613501</b>





Tallos Modular™ 2FS Monitor Arm			
	Clamp/Grommet mount, VESA, max. 2 x 9 kg, max. 40", static.		
			
	Black	White	Silver
	<b>8615301</b>	<b>8616301</b>	<b>8613701</b>

Tallos Modular™ 2FFS Monitor Arm			
	Clamp/Grommet mount, VESA, slider, max. 2 x 9 kg, max. 40", static, extra reach.		
			
	Black	White	Silver
	<b>8615401</b>	<b>8616401</b>	<b>8613801</b>

Tallos Modular™ 2MS Monitor Arm			
	Clamp/Grommet mount, VESA slider, max. 2 x 9 kg, max. 40", gas spring.		
			
	Black	White	Silver
	<b>8615601</b>	<b>8616601</b>	<b>8614001</b>

Tallos Modular™ 2FMS Monitor Arm			
	Clamp/Grommet mount, VESA Slider, max. 2 x 9 kg, max. 40", gas spring, extra reach.		
			
	Black	White	Silver
	<b>8615501</b>	<b>8616501</b>	<b>8613901</b>

Tallos Modular™ 3FFS Monitor Arm			
	Clamp/Grommet mount, VESA Slider, max. 3 x 9 kg, max. 30", static.		
			
	Black	White	Silver
	<b>8615701</b>	<b>8616701</b>	<b>8614101</b>



Tallos Modular™ 3FMS Monitor Arm			
	Clamp/Grommet mount, VESA Slider, max. 3 x 9 kg, max. 32", gas spring.		
			
	Black	White	Silver
	<b>8615801</b>	<b>8616801</b>	<b>8614201</b>

# TALLO MODULAR™ CONFIGURATIONS

**Tallo Modular™ 4FFS Monitor Arm**



Clamp/Grommet mount, VESA Sliders, max. 4 x 7 kg, max. 40", gas spring



		
Black	White	Silver

<b>8610001</b>	<b>8610101</b>	<b>8610201</b>
----------------	----------------	----------------

**Tallo Modular™ 4FMS Monitor Arm**



Clamp/Grommet mount, VESA Slider, max. 4 x 7 kg, max. 40", gas spring.

		
Black	White	Silver

<b>8610301</b>	<b>8610401</b>	<b>8610501</b>
----------------	----------------	----------------

**Tallo™ Laptop accessory**



Accessory suited for all Tallo monitor arms, max. 18".



		
Black	White	Silver

<b>8000401</b>	<b>8000501</b>	<b>8000601</b>
----------------	----------------	----------------

**Tallo™ Flexcharge - EU**



Charging accessory suited for all Tallo monitor arms, Qi, USB A + C

		
Black	White	Silver

<b>7503001</b>	<b>7502601</b>	<b>7503401</b>
----------------	----------------	----------------



# CHICAGO MONITOR ARMS



Introducing the Chicago range, the go-to solution known for its strong core performance and seamless adjustments in a top mount configuration, ensuring optimal workspace ergonomics. Crafted with precision ball joints, a high-quality gas spring, and integrated cable management, this range is designed to elevate any workspace to new heights.



## SCREEN MOUNT OPTIONS

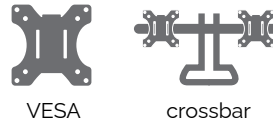

## MOVEMENT LEVEL OPTIONS















## DESK MOUNT OPTIONS

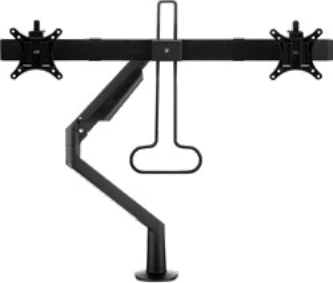

## ADJUSTABILITY OPTIONS



Chicago Single Monitor Arm				
	Top mount, VESA, max. 12 kg, gas spring, max. 40".			
				
	Black	White	Silver	Polished aluminium
	100091505	100091586	100091500	100091576
Chicago Dual Monitor Arm				
	Top mount, VESA, max. 12 kg, gas spring, max. 40".			
				
	Black	White	Silver	
	100091563	100091668	100091407	
Chicago Dual Crossbar Monitor Arm				
	Top mount, VESA, max. 12 kg, gas spring, max. 32".			
				
	Black	White	Silver	Polished aluminium
	100091351	100091582	100091460	100091490

# EPPA™ MONITOR ARMS

Beneath the Eppa's minimal design is a reliable and smooth finger touch gas spring adjustment control. This allows the user to effortlessly adjust the height and position of their monitors. The Eppa range of monitor arms offers a comfortable viewing distance regardless of the depth of your desk top.

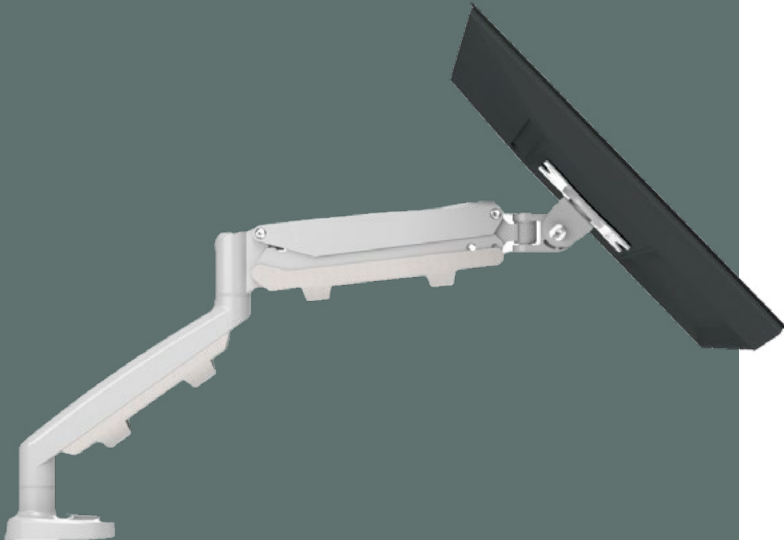

## SCREEN MOUNT OPTIONS



VESA

## MOVEMENT LEVEL OPTIONS



gas spring

## DESK MOUNT OPTIONS



clamp



grommet

## ADJUSTABILITY OPTIONS



rotation

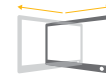

pan



tilt



rotation stop

### Eppa™ Single Monitor Arm



Clamp/Grommet mount, VESA, max. 8 kg, gas spring, max. 40".



Black

9683101



White

9683201



Silver

9683001

### Eppa™ Dual Monitor Arm



Clamp/Grommet mount, VESA, max. 2 x 8 kg, gas spring, max. 40".



Black

9683401



White

9683501



Silver

9683301

# SMARTVIEW MONITOR ARMS



SmartView Monitor Arms, a sleek and versatile solution designed to enhance productivity and comfort, while emphasizing luxurious leather details. Featuring a robust construction and dynamic movement with the mechanical spring arm. SmartView Monitor Arms provides flexible positioning options for up to two monitors. Perfect for both professional offices and home workspaces, it accommodates up to two monitors, providing users with flexible positioning options to optimize ergonomic viewing and minimize workspace clutter.



## SCREEN MOUNT OPTIONS



VESA

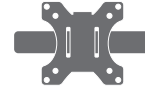

slider

## MOVEMENT LEVEL OPTIONS



mechanical spring

## DESK MOUNT OPTIONS



clamp



grommet

## ADJUSTABILITY OPTIONS



rotation

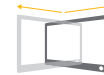

pan



tilt



rotation stop

### Smartview Single Monitor Arm



Clamp mount desktop range 10 - 60 mm, VESA, max. 9 kg, mechanical spring, max. 40".



Black



White

100091614

100098871

### Smartview Dual Monitor Arm



Clamp mount desktop range 10 - 60 mm, VESA Sliders, max. 2 x 9 kg, mechanical spring, max. 32".



Black



White

100091368

100091593

# SWING MONITOR ARMS

Introducing the Swing range of Monitor Arms, featuring both single and crossbar solutions to cater to diverse workspace needs. Crafted with simplicity and robustness in mind, this product line offers a reliable solution for workspaces constrained by limited space below or behind the desktop, thanks to its top mounting option. Designed with ergonomics in mind, these monitor arms provide a comfortable and efficient solution for any workspace, seamlessly integrating into the design of any office environment.



## SCREEN MOUNT OPTIONS



VESA

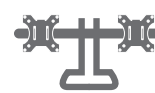

crossbar

## MOVEMENT LEVEL OPTIONS



gas spring

## DESK MOUNT OPTIONS



top mount

## ADJUSTABILITY OPTIONS



rotation



pan



tilt



rotation stop

### Swing Single Monitor Arm



Top mount desktop range 10 - 50 mm, VESA, max. 8 kg, gas spring, max. 40°.



Black

100091675

### Swing Dual Crossbar Monitor Arm



Top mount desktop range 10 - 45 mm, VESA, max. 16 kg, gas spring, max. 2 x 32°.



Black

100091431

# SKYLON MONITOR ARMS

Introducing the Skylon Monitor Arms – a sophisticated yet straightforward solution tailored for more personal office setups. Elevate the monitors with durable arms offering static height adjustment, ideal for long-term configurations. Whether you choose a single, dual, triple, quad or hexa monitor setup, the Skylon series provides versatility while maintaining a sleek, minimalist design.



## SCREEN MOUNT OPTIONS



## MOVEMENT LEVEL OPTIONS



## DESK MOUNT OPTIONS



## ADJUSTABILITY OPTIONS



### Skylon Single Short Monitor Arm



Clamp mount with desktop range 0 - 50 mm, VESA, max. 8 kg, max. 32".



Black



White



Silver

100091662

100091329

100091632

### Skylon Single Monitor Arm



Clamp mount with desktop range 0 - 50 mm, VESA, max. 2 x 8 kg, max. 32".



Black



White



Silver

100091384

100091622

100091627

### Skylon Dual Monitor Arm



Clamp mount with desktop range 0 - 50 mm, VESA, max. 2 x 8 kg, max. 32".



Black



White



Silver

100091435

100091626

100091658

### Skylon Triple Monitor Arm



Clamp mount with desktop range 0 - 50 mm, VESA, max. 3 x 8 kg, max. 27".



Black



White



Silver

100091403

100091492

100091474

### Skylon Quadruple Monitor Arm



Clamp mount with desktop range 0 - 50 mm, VESA, max. 4 x 8 kg, max. 27".



Black



White



Silver

Made to order

Made to order

100091358

### Skylon 6 Monitor Arm

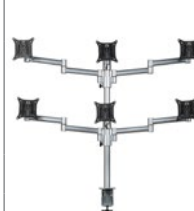

Clamp mount with desktop range 0 - 50 mm, VESA, max. 6 x 8 kg, max. 27".



Black



White



Silver

Made to order

Made to order

100091436

# PCON

## INSPIRE DYNAMIC WORKSPACES

### Product Configuration

Utilize configurable data and a robust toolkit for designing, presenting, and selling interior solutions to create realistic office renders including Fellowes products in 3D.

### Access to Configurable 3D Models

Explore our monitor arms, power & cable management systems with configurable 3D models. Access crucial product information including prices, brochures, images, and videos.

### Apps for Enhanced Design and Sales

Leverage powerful applications for desktop design, client presentations during on-site consultations, and seamless quote and offer creation.

### Interactive Configuration

Our products offer a multitude of options and dependencies. With pCon, embrace this diversity and access our interactively configurable product data in 3D. Witness all available options, and receive real-time updates on geometry, price, and product code with every configuration change.

### 2D & 3D File Downloads

Download product data in the required 2D or 3D format effortlessly. Access the files you need to streamline your design and sales processes.





**Fellowes** | FAMILY BUSINESS  
Brands™ SINCE 1917